



Aluminum electrolytic capacitors

Single-ended capacitors

Series/Type: B41858
Date: December 2010

Long-life grade capacitors for professional applications

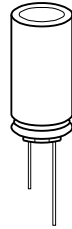

Applications

- For use in output circuits of switch-mode power supplies of compact design
- For professional industrial electronics, telecommunications and data processing equipment
- Automotive electronics

Features

- Low impedance at high frequency
- Low ESR
- High ripple current capability
- High reliability and long useful life
- RoHS-compatible

Construction

- Radial leads
- Charge-discharge proof, polar
- Aluminum case with insulating sleeve
- Minus pole marking on the insulating sleeve
- Case with safety vent

Delivery mode

Terminal configurations and packing:

- Bulk
- Taped, Ammo pack
- Cut (see chapter "Single-ended – Taping, packing and lead configurations, Cut leads (Chapter B)")
- Kinked (see chapter "Single-ended – Taping, packing and lead configurations, Kinked leads (Chapter B)")
- PAPR (protection against polarity reversal):
crimped leads, J leads, bent leads

Refer to chapter "Single-ended capacitors – Taping, packing and lead configurations" for further details.

Specifications and characteristics in brief

Rated voltage V_R	10 ... 100 V DC							
Surge voltage V_S	$1.15 \cdot V_R$							
Rated capacitance C_R	22 ... 10000 μF							
Capacitance tolerance	$\pm 20\% \triangle M$							
Dissipation factor $\tan \delta$ (20 °C, 120 Hz)	For capacitance higher than 1000 μF add 0.02 for every increase of 1000 μF .							
	V_R (V DC)	10	16	25	35	50	63	100
	$\tan \delta$ (max.)	0.19	0.16	0.14	0.12	0.10	0.10	0.08
Leakage current I_{leak} (20 °C, 5 min)	$I_{\text{leak}} = 0.01 \mu\text{A} \cdot \left(\frac{C_R}{\mu\text{F}} \cdot \frac{V_R}{V} \right)$							
Self-inductance ESL	Diameter (mm)	8 ... 12.5		16		18		
	ESL (nH)	20		26		34		
Useful life 105 °C; V_R ; $I_{\text{AC,R}}$	> 3000 h for $d = 8$ mm > 5000 h for $d \geq 10$ mm							
Requirements	$\Delta C/C \leq \pm 40\%$ of initial value $\tan \delta \leq 3$ times initial specified limit $I_{\text{leak}} \leq$ initial specified limit							
Voltage endurance test 105 °C; V_R	3000 h for $d = 8$ mm 5000 h for $d \geq 10$ mm							
Post test requirements	$\Delta C/C \leq \pm 30\%$ of initial value $\tan \delta \leq 2$ times initial specified limit $I_{\text{leak}} \leq$ initial specified limit							
Vibration resistance test	To IEC 60068-2-6, test Fc: Frequency range 10 Hz ... 2 kHz, displacement amplitude max. 1.5 mm, acceleration max. 20 g, duration 3×2 h. Capacitor rigidly clamped by the aluminum case.							
IEC climatic category	To IEC 60068-1: 55/105/56 (–55 °C/+105 °C/56 days damp heat test)							
Sectional specification	IEC 60384-4, AEC Q200							



B41858

Low impedance – 105 °C

Dimensional drawings

With stand-off rubber seal

Diameters (mm): 10, 12.5, 16, 18

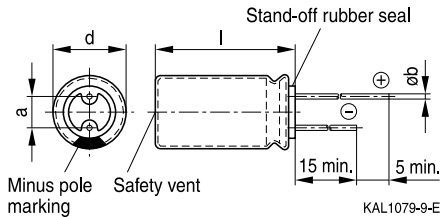

With flat rubber seal

Diameter (mm): 8

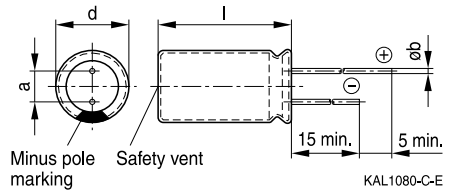

Dimensions and weights

Dimensions (mm)				Approx. weight
d +0.5	l	a ±0.5	b	g
8	11.5 +1.5	3.5	0.60 ±0.05	1.0
10	12.5 +1.0	5.0	0.60 ±0.05	1.6
10	16 +1.0	5.0	0.60 ±0.05	1.9
10	20 +2.0	5.0	0.60 ±0.05	2.6
12.5	20 +2.0	5.0	0.60 ±0.05	3.6
12.5	25 +2.0	5.0	0.60 ±0.05	4.5
12.5	30 +2.0	5.0	0.80 ±0.05	5.3
12.5	40 +2.0	5.0	0.80 ±0.05	7.4
16	20 +2.0	7.5	0.80 ±0.05	5.5
16	25 +2.0	7.5	0.80 ±0.05	7.5
16	31.5 +2.0	7.5	0.80 ±0.05	7.8
16	35.5 +2.0	7.5	0.80 ±0.05	9.2
18	20 +2.0	7.5	0.80 ±0.1	8.0
18	25 +2.0	7.5	0.80 ±0.1	9.0
18	31.5 +2.0	7.5	0.80 ±0.1	11.0
18	35 +2.0	7.5	0.80 ±0.1	13.0
18	40 +2.0	7.5	0.80 ±0.1	16.0

Overview of available types

V_R (V DC)	10	16	25	35
	Case dimensions $d \times l$ (mm)			
C_R (μF)				
100				8 × 11.5
120				8 × 11.5
150				8 × 11.5
180			8 × 11.5	10 × 12.5
220			8 × 11.5	10 × 12.5
270		8 × 11.5	10 × 12.5	
330	8 × 11.5	8 × 11.5	10 × 12.5	10 × 16
390	8 × 11.5			
470	8 × 11.5	10 × 12.5	10 × 16	10 × 20
560	10 × 12.5	10 × 16	10 × 16	10 × 20
680	10 × 12.5	10 × 16	10 × 20	12.5 × 20
820	10 × 16	10 × 20	10 × 20	
1000	10 × 16	10 × 20	12.5 × 20	12.5 × 25 16 × 20
1200	10 × 16	10 × 20		16 × 20
1500	10 × 20	12.5 × 20	12.5 × 25	12.5 × 40 16 × 25
1800	10 × 20	12.5 × 25	16 × 20	16 × 25 18 × 20
2200	12.5 × 20	12.5 × 25	12.5 × 40 16 × 25 18 × 20	18 × 25
2700	12.5 × 25	16 × 20	16 × 31.5 18 × 20	18 × 31.5
3300	12.5 × 25 16 × 20	12.5 × 40 16 × 25	18 × 25	16 × 35.5 18 × 31.5
3900	12.5 × 40 16 × 20	16 × 31.5 18 × 20	16 × 35.5 18 × 31.5	18 × 35
4700	18 × 20	18 × 25	18 × 31.5	18 × 40
5600	12.5 × 40		18 × 35	
6800	16 × 31.5	18 × 31.5	18 × 40	
8200	18 × 31.5	18 × 35		
10000	18 × 35	18 × 40		

B41858
Low impedance – 105 °C

V_R (V DC)	50	63	100
	Case dimensions $d \times l$ (mm)		
C_R (μ F)			
22			8 × 11.5
33			10 × 16
47			10 × 20
68		8 × 11.5	
100	8 × 11.5	10 × 12.5	12.5 × 20
120	10 × 12.5	10 × 16	12.5 × 25
150	10 × 12.5	10 × 16	
180	10 × 16	10 × 20	12.5 × 30 16 × 20
220	10 × 16	10 × 20	16 × 25
270		12.5 × 20	12.5 × 40 18 × 20
330	10 × 20	12.5 × 20	16 × 31.5 18 × 25
390		12.5 × 25	18 × 31.5
470	12.5 × 20	12.5 × 25 16 × 20	18 × 35
560	12.5 × 25		18 × 35
680	12.5 × 30	12.5 × 40 16 × 25 18 × 20	18 × 40
820	12.5 × 40 16 × 20	16 × 31.5 18 × 25	
1000	16 × 31.5 18 × 20	16 × 31.5	
1200	18 × 20	18 × 31.5	
1500	18 × 25	18 × 35	
1800	16 × 35.5 18 × 31.5	18 × 40	
2200	18 × 35		
2700	18 × 40		

Other voltage and capacitance ratings are available upon request.

Technical data and ordering codes

C_R	Case dimensions	ESR_{max} 10 kHz –40 °C	ESR_{max} 10 kHz 20 °C	Z_{max} 100 kHz 20 °C	$I_{AC,R}$ 100 kHz 105 °C	Ordering code (composition see below)
μF	d × l mm	Ω	Ω	Ω	mA	
$V_R = 10 V DC$						
330	8 × 11.5	2.195	0.274	0.246	436	B41858C3337M***
390	8 × 11.5	2.195	0.274	0.246	436	B41858C3397M***
470	8 × 11.5	2.195	0.274	0.246	436	B41858C3477M***
560	10 × 12.5	1.035	0.129	0.113	746	B41858C3567M***
680	10 × 12.5	1.035	0.129	0.113	746	B41858C3687M***
820	10 × 16	0.946	0.118	0.105	846	B41858C3827M***
1000	10 × 16	0.946	0.118	0.105	846	B41858C3108M***
1200	10 × 16	0.944	0.118	0.105	846	B41858C3128M***
1500	10 × 20	0.584	0.073	0.062	1202	B41858C3158M***
1800	10 × 20	0.584	0.073	0.062	1202	B41858C3188M***
2200	12.5 × 20	0.496	0.062	0.060	1396	B41858C3228M***
2700	12.5 × 25	0.327	0.041	0.034	2028	B41858C3278M***
3300	12.5 × 25	0.327	0.041	0.034	2028	B41858C3338M***
3300	16 × 20	0.307	0.038	0.033	2146	B41858D3338M***
3900	12.5 × 40	0.240	0.030	0.025	2858	B41858C3398M***
3900	16 × 20	0.307	0.038	0.033	2146	B41858D3398M***
4700	18 × 20	0.271	0.034	0.031	2381	B41858C3478M***
5600	12.5 × 40	0.243	0.030	0.025	2858	B41858C3568M***
6800	16 × 31.5	0.192	0.024	0.022	3122	B41858C3688M***
8200	18 × 31.5	0.165	0.021	0.020	3539	B41858C3828M***
10000	18 × 35	0.160	0.020	0.018	3864	B41858C3109M***

Composition of ordering code

*** = Version

000 = for standard leads, bulk

001 = for kinked leads, bulk (for d × l = 10 × 20 mm to 18 × 40 mm, excluding 12.5 × 30/40 mm)

 002 = for cut leads, bulk (for \varnothing 10 ... 18 mm, excluding d × l = 12.5 × 30/40 mm)

 003 = for crimped leads, blister (for \varnothing 16 ... 18 mm)

 004 = for J leads, blister (for \varnothing 10 ... 18 mm, excluding d × l = 12.5 × 30/40 and 18 × 40 mm)

 006 = for taped leads, Ammo pack, lead spacing F = 3.5 mm (for \varnothing 8 mm)

008 = for taped leads, Ammo pack, lead spacing F = 5.0 mm (for d × l = 8 × 11.5 ... 12.5 × 25 mm)

009 = for taped leads, Ammo pack, lead spacing F = 7.5 mm (for d × l = 16 × 20 ... 16 × 31.5 mm and 18 × 20 ... 18 × 31.5 mm)

 012 = for bent 90° leads, blister (for \varnothing 16 ... 18 mm)

B41858
Low impedance – 105 °C
Technical data and ordering codes

C_R	Case dimensions	ESR_{max} 10 kHz -40 °C	ESR_{max} 10 kHz 20 °C	Z_{max} 100 kHz 20 °C	$I_{AC,R}$ 100 kHz 105 °C	Ordering code (composition see below)
μF	d × l mm	Ω	Ω	Ω	mA	
$V_R = 16 V DC$						
270	8 × 11.5	2.192	0.274	0.246	436	B41858D4277M***
330	8 × 11.5	2.192	0.274	0.246	436	B41858D4337M***
470	10 × 12.5	1.035	0.129	0.113	746	B41858C4477M***
560	10 × 16	0.944	0.118	0.105	846	B41858C4567M***
680	10 × 16	0.946	0.118	0.105	846	B41858C4687M***
820	10 × 20	0.584	0.073	0.062	1202	B41858C4827M***
1000	10 × 20	0.584	0.073	0.062	1202	B41858C4108M***
1200	10 × 20	0.584	0.073	0.062	1202	B41858C4128M***
1500	12.5 × 20	0.496	0.062	0.060	1396	B41858C4158M***
1800	12.5 × 25	0.327	0.041	0.034	2028	B41858C4188M***
2200	12.5 × 25	0.327	0.041	0.034	2028	B41858C4228M***
2700	16 × 20	0.307	0.038	0.033	2146	B41858C4278M***
3300	12.5 × 40	0.243	0.030	0.025	2858	B41858D4338M***
3300	16 × 25	0.251	0.031	0.029	2483	B41858C4338M***
3900	16 × 31.5	0.192	0.024	0.022	3122	B41858D4398M***
3900	18 × 20	0.271	0.034	0.031	2381	B41858C4398M***
4700	18 × 25	0.217	0.027	0.024	2941	B41858C4478M***
6800	18 × 31.5	0.165	0.021	0.020	3539	B41858C4688M***
8200	18 × 35	0.160	0.020	0.018	3864	B41858C4828M***
10000	18 × 40	0.125	0.016	0.015	4467	B41858C4109M***

Composition of ordering code

*** = Version

- 000 = for standard leads, bulk
- 001 = for kinked leads, bulk (for d × l = 10 × 20 mm to 18 × 40 mm, excluding 12.5 × 30/40 mm)
- 002 = for cut leads, bulk (for \varnothing 10 ... 18 mm, excluding d × l = 12.5 × 30/40 mm)
- 003 = for crimped leads, blister (for \varnothing 16 ... 18 mm)
- 004 = for J leads, blister (for \varnothing 10 ... 18 mm, excluding d × l = 12.5 × 30/40 and 18 × 40 mm)
- 006 = for taped leads, Ammo pack, lead spacing F = 3.5 mm (for \varnothing 8 mm)
- 008 = for taped leads, Ammo pack, lead spacing F = 5.0 mm (for d × l = 8 × 11.5 ... 12.5 × 25 mm)
- 009 = for taped leads, Ammo pack, lead spacing F = 7.5 mm (for d × l = 16 × 20 ... 16 × 31.5 mm and 18 × 20 ... 18 × 31.5 mm)
- 012 = for bent 90° leads, blister (for \varnothing 16 ... 18 mm)

Technical data and ordering codes

C_R	Case dimensions	ESR_{max} 10 kHz –40 °C	ESR_{max} 10 kHz 20 °C	Z_{max} 100 kHz 20 °C	$I_{AC,R}$ 100 kHz 105 °C	Ordering code (composition see below)
μF	$d \times l$ mm	Ω	Ω	Ω	mA	
$V_R = 25 V DC$						
180	8 × 11.5	2.192	0.274	0.246	436	B41858D5187M***
220	8 × 11.5	2.192	0.274	0.246	436	B41858D5227M***
270	10 × 12.5	1.032	0.129	0.113	746	B41858C5277M***
330	10 × 12.5	1.035	0.129	0.113	746	B41858C5337M***
470	10 × 16	0.946	0.118	0.105	846	B41858C5477M***
560	10 × 16	0.944	0.118	0.105	846	B41858C5567M***
680	10 × 20	0.584	0.073	0.062	1202	B41858C5687M***
820	10 × 20	0.584	0.073	0.062	1202	B41858C5827M***
1000	12.5 × 20	0.496	0.062	0.060	1396	B41858C5108M***
1500	12.5 × 25	0.327	0.041	0.034	2028	B41858C5158M***
1800	16 × 20	0.307	0.038	0.033	2146	B41858C5188M***
2200	12.5 × 40	0.243	0.030	0.025	2858	B41858D5228M***
2200	16 × 25	0.251	0.031	0.029	2483	B41858C5228M***
2200	18 × 20	0.248	0.031	0.031	2381	B41858E5228M***
2700	16 × 31.5	0.192	0.024	0.022	3122	B41858D5278M***
2700	18 × 20	0.271	0.034	0.031	2381	B41858C5278M***
3300	18 × 25	0.217	0.027	0.024	2941	B41858C5338M***
3900	16 × 35.5	0.168	0.021	0.019	3408	B41858D5398M***
3900	18 × 31.5	0.165	0.021	0.020	3539	B41858C5398M***
4700	18 × 31.5	0.168	0.021	0.020	3539	B41858D5478M***
5600	18 × 35	0.160	0.020	0.018	3864	B41858D5568M***
6800	18 × 40	0.128	0.016	0.015	4467	B41858C5688M***

Composition of ordering code

*** = Version

- 000 = for standard leads, bulk
- 001 = for kinked leads, bulk (for $d \times l = 10 \times 20$ mm to 18×40 mm, excluding $12.5 \times 30/40$ mm)
- 002 = for cut leads, bulk (for $\varnothing 10 \dots 18$ mm, excluding $d \times l = 12.5 \times 30/40$ mm)
- 003 = for crimped leads, blister (for $\varnothing 16 \dots 18$ mm)
- 004 = for J leads, blister (for $\varnothing 10 \dots 18$ mm, excluding $d \times l = 12.5 \times 30/40$ and 18×40 mm)
- 006 = for taped leads, Ammo pack, lead spacing $F = 3.5$ mm (for $\varnothing 8$ mm)
- 008 = for taped leads, Ammo pack, lead spacing $F = 5.0$ mm (for $d \times l = 8 \times 11.5 \dots 12.5 \times 25$ mm)
- 009 = for taped leads, Ammo pack, lead spacing $F = 7.5$ mm (for $d \times l = 16 \times 20 \dots 16 \times 31.5$ mm and $18 \times 20 \dots 18 \times 31.5$ mm)
- 012 = for bent 90° leads, blister (for $\varnothing 16 \dots 18$ mm)

B41858
Low impedance – 105 °C
Technical data and ordering codes

C_R 120 Hz 20 °C μF	Case dimensions $d \times l$ mm	ESR_{max} 10 kHz -40 °C Ω	ESR_{max} 10 kHz 20 °C Ω	Z_{max} 100 kHz 20 °C Ω	$I_{\text{AC,R}}$ 100 kHz 105 °C mA	Ordering code (composition see below)
$V_R = 35 \text{ V DC}$						
100	8 × 11.5	2.192	0.274	0.246	436	B41858C7107M***
120	8 × 11.5	2.192	0.274	0.246	436	B41858D7127M***
150	8 × 11.5	2.192	0.274	0.246	436	B41858C7157M***
180	10 × 12.5	1.035	0.129	0.113	746	B41858C7187M***
220	10 × 12.5	1.035	0.129	0.113	746	B41858C7227M***
330	10 × 16	0.946	0.118	0.105	846	B41858C7337M***
470	10 × 20	0.584	0.073	0.062	1202	B41858C7477M***
560	10 × 20	0.584	0.073	0.062	1202	B41858C7567M***
680	12.5 × 20	0.496	0.062	0.060	1396	B41858C7687M***
1000	12.5 × 25	0.327	0.041	0.034	2028	B41858C7108M***
1000	16 × 20	0.304	0.038	0.033	2146	B41858D7108M***
1200	16 × 20	0.307	0.038	0.033	2146	B41858C7128M***
1500	12.5 × 40	0.243	0.030	0.025	2858	B41858D7158M***
1500	16 × 25	0.251	0.031	0.029	2483	B41858C7158M***
1800	16 × 25	0.248	0.031	0.029	2483	B41858E7188M***
1800	18 × 20	0.271	0.034	0.031	2381	B41858C7188M***
2200	18 × 25	0.217	0.027	0.024	2941	B41858C7228M***
2700	18 × 31.5	0.165	0.021	0.020	3539	B41858C7278M***
3300	16 × 35.5	0.168	0.021	0.019	3408	B41858E7338M***
3300	18 × 31.5	0.168	0.021	0.020	3539	B41858D7338M***
3900	18 × 35	0.160	0.020	0.018	3864	B41858C7398M***
4700	18 × 40	0.125	0.016	0.015	4467	B41858C7478M***

Composition of ordering code

*** = Version

- 000 = for standard leads, bulk
- 001 = for kinked leads, bulk (for $d \times l = 10 \times 20 \text{ mm}$ to $18 \times 40 \text{ mm}$, excluding $12.5 \times 30/40 \text{ mm}$)
- 002 = for cut leads, bulk (for $\varnothing 10 \dots 18 \text{ mm}$, excluding $d \times l = 12.5 \times 30/40 \text{ mm}$)
- 003 = for crimped leads, blister (for $\varnothing 16 \dots 18 \text{ mm}$)
- 004 = for J leads, blister (for $\varnothing 10 \dots 18 \text{ mm}$, excluding $d \times l = 12.5 \times 30/40$ and $18 \times 40 \text{ mm}$)
- 006 = for taped leads, Ammo pack, lead spacing $F = 3.5 \text{ mm}$ (for $\varnothing 8 \text{ mm}$)
- 008 = for taped leads, Ammo pack, lead spacing $F = 5.0 \text{ mm}$ (for $d \times l = 8 \times 11.5 \dots 12.5 \times 25 \text{ mm}$)
- 009 = for taped leads, Ammo pack, lead spacing $F = 7.5 \text{ mm}$ (for $d \times l = 16 \times 20 \dots 16 \times 31.5 \text{ mm}$ and $18 \times 20 \dots 18 \times 31.5 \text{ mm}$)
- 012 = for bent 90° leads, blister (for $\varnothing 16 \dots 18 \text{ mm}$)

Technical data and ordering codes

C_R	Case dimensions	ESR_{max} 10 kHz -40 °C	ESR_{max} 10 kHz 20 °C	Z_{max} 100 kHz 20 °C	$I_{AC,R}$ 100 kHz 105 °C	Ordering code (composition see below)
μF	$d \times l$ mm	Ω	Ω	Ω	mA	
$V_R = 50 V DC$						
100	8 × 11.5	5.168	0.646	0.573	340	B41858C6107M***
120	10 × 12.5	2.984	0.373	0.336	555	B41858C6127M***
150	10 × 12.5	2.984	0.373	0.336	555	B41858C6157M***
180	10 × 16	1.400	0.175	0.160	778	B41858C6187M***
220	10 × 16	1.400	0.175	0.160	778	B41858C6227M***
330	10 × 20	1.000	0.125	0.118	1030	B41858C6337M***
470	12.5 × 20	0.880	0.110	0.104	1300	B41858C6477M***
560	12.5 × 25	0.712	0.089	0.082	1490	B41858C6567M***
680	12.5 × 30	0.360	0.045	0.043	2140	B41858C6687M***
820	12.5 × 40	0.269	0.034	0.032	2799	B41858C6827M***
820	16 × 20	0.401	0.050	0.046	1820	B41858D6827M***
1000	16 × 31.5	0.260	0.032	0.030	2653	B41858C6108M***
1000	18 × 20	0.477	0.048	0.044	1997	B41858D6108M***
1200	18 × 20	0.384	0.048	0.044	1997	B41858C6128M***
1500	18 × 25	0.382	0.038	0.036	2417	B41858C6158M***
1800	16 × 35.5	0.232	0.029	0.026	2896	B41858D6188M***
1800	18 × 31.5	0.300	0.030	0.028	2989	B41858C6188M***
2200	18 × 35	0.268	0.027	0.024	3320	B41858C6228M***
2700	18 × 40	0.210	0.021	0.020	3871	B41858C6278M***

Composition of ordering code

*** = Version

- 000 = for standard leads, bulk
- 001 = for kinked leads, bulk (for $d \times l = 10 \times 20$ mm to 18×40 mm, excluding $12.5 \times 30/40$ mm)
- 002 = for cut leads, bulk (for $\varnothing 10 \dots 18$ mm, excluding $d \times l = 12.5 \times 30/40$ mm)
- 003 = for crimped leads, blister (for $\varnothing 16 \dots 18$ mm)
- 004 = for J leads, blister (for $\varnothing 10 \dots 18$ mm, excluding $d \times l = 12.5 \times 30/40$ and 18×40 mm)
- 006 = for taped leads, Ammo pack, lead spacing $F = 3.5$ mm (for $\varnothing 8$ mm)
- 008 = for taped leads, Ammo pack, lead spacing $F = 5.0$ mm (for $d \times l = 8 \times 11.5 \dots 12.5 \times 25$ mm)
- 009 = for taped leads, Ammo pack, lead spacing $F = 7.5$ mm (for $d \times l = 16 \times 20 \dots 16 \times 31.5$ mm and $18 \times 20 \dots 18 \times 31.5$ mm)
- 012 = for bent 90° leads, blister (for $\varnothing 16 \dots 18$ mm)

B41858
Low impedance – 105 °C
Technical data and ordering codes

C_R	Case dimensions	ESR_{max} 10 kHz -40 °C	ESR_{max} 10 kHz 20 °C	Z_{max} 100 kHz 20 °C	$I_{AC,R}$ 100 kHz 105 °C	Ordering code (composition see below)
μF	d × l mm	Ω	Ω	Ω	mA	
$V_R = 63 V DC$						
68	8 × 11.5	4.328	0.541	0.488	310	B41858C8686M***
100	10 × 12.5	4.616	0.577	0.500	354	B41858C8107M***
120	10 × 16	3.075	0.308	0.279	519	B41858C8127M***
150	10 × 16	2.464	0.308	0.279	519	B41858C8157M***
180	10 × 20	1.986	0.199	0.180	705	B41858C8187M***
220	10 × 20	1.592	0.199	0.180	705	B41858C8227M***
270	12.5 × 20	1.688	0.169	0.153	876	B41858C8277M***
330	12.5 × 20	1.688	0.169	0.153	876	B41858C8337M***
390	12.5 × 25	1.236	0.124	0.112	1118	B41858C8397M***
470	12.5 × 25	0.992	0.124	0.112	1118	B41858E8477M***
470	16 × 20	1.037	0.104	0.094	1272	B41858C8477M***
680	12.5 × 40	0.717	0.072	0.065	1785	B41858C8687M***
680	16 × 25	0.772	0.077	0.070	1600	B41858D8687M***
680	18 × 20	0.960	0.096	0.087	1427	B41858E8687M***
820	16 × 31.5	0.541	0.054	0.049	2092	B41858C8827M***
820	18 × 25	0.761	0.076	0.069	1735	B41858D8827M***
1000	16 × 31.5	0.432	0.054	0.049	2092	B41858C8108M***
1200	18 × 31.5	0.518	0.052	0.047	2294	B41858C8128M***
1500	18 × 35	0.441	0.044	0.040	2592	B41858C8158M***
1800	18 × 40	0.375	0.038	0.034	2967	B41858C8188M***

Composition of ordering code

*** = Version

000 = for standard leads, bulk

001 = for kinked leads, bulk (for d × l = 10 × 20 mm to 18 × 40 mm, excluding 12.5 × 30/40 mm)

 002 = for cut leads, bulk (for \varnothing 10 ... 18 mm, excluding d × l = 12.5 × 30/40 mm)

 003 = for crimped leads, blister (for \varnothing 16 ... 18 mm)

 004 = for J leads, blister (for \varnothing 10 ... 18 mm, excluding d × l = 12.5 × 30/40 and 18 × 40 mm)

 006 = for taped leads, Ammo pack, lead spacing F = 3.5 mm (for \varnothing 8 mm)

008 = for taped leads, Ammo pack, lead spacing F = 5.0 mm (for d × l = 8 × 11.5 ... 12.5 × 25 mm)

009 = for taped leads, Ammo pack, lead spacing F = 7.5 mm (for d × l = 16 × 20 ... 16 × 31.5 mm and 18 × 20 ... 18 × 31.5 mm)

 012 = for bent 90° leads, blister (for \varnothing 16 ... 18 mm)

Technical data and ordering codes

C_R	Case dimensions	ESR_{max} 10 kHz -40 °C	ESR_{max} 10 kHz 20 °C	Z_{max} 100 kHz 20 °C	$I_{AC,R}$ 100 kHz 105 °C	Ordering code (composition see below)
μF	d × l mm	Ω	Ω	Ω	mA	
$V_R = 100 V DC$						
22	8 × 11.5	12.219	1.222	1.114	205	B41858C9226M***
33	10 × 16	6.542	0.654	0.589	357	B41858C9336M***
47	10 × 20	3.688	0.461	0.423	460	B41858C9476M***
100	12.5 × 20	3.048	0.305	0.281	647	B41858C9107M***
120	12.5 × 25	2.038	0.204	0.188	864	B41858C9127M***
180	12.5 × 30	1.732	0.173	0.159	1009	B41858C9187M***
180	16 × 20	1.313	0.131	0.122	1119	B41858D9187M***
220	16 × 25	0.985	0.099	0.091	1402	B41858C9227M***
270	12.5 × 40	1.314	0.131	0.121	1309	B41858C9277M***
270	18 × 20	1.260	0.126	0.119	1220	B41858D9277M***
330	16 × 31.5	0.973	0.097	0.090	1546	B41858C9337M***
330	18 × 25	1.008	0.101	0.095	1477	B41858D9337M***
390	18 × 31.5	0.720	0.072	0.068	1907	B41858C9397M***
470	18 × 35	0.679	0.068	0.063	2061	B41858C9477M***
560	18 × 35	0.679	0.068	0.063	2061	B41858C9567M***
680	18 × 40	0.438	0.044	0.042	2683	B41858C9687M***

Composition of ordering code

*** = Version

000 = for standard leads, bulk

001 = for kinked leads, bulk (for d × l = 10 × 20 mm to 18 × 40 mm, excluding 12.5 × 30/40 mm)

 002 = for cut leads, bulk (for \varnothing 10 ... 18 mm, excluding d × l = 12.5 × 30/40 mm)

 003 = for crimped leads, blister (for \varnothing 16 ... 18 mm)

 004 = for J leads, blister (for \varnothing 10 ... 18 mm, excluding d × l = 12.5 × 30/40 and 18 × 40 mm)

 006 = for taped leads, Ammo pack, lead spacing F = 3.5 mm (for \varnothing 8 mm)

008 = for taped leads, Ammo pack, lead spacing F = 5.0 mm (for d × l = 8 × 11.5 ... 12.5 × 25 mm)

009 = for taped leads, Ammo pack, lead spacing F = 7.5 mm (for d × l = 16 × 20 ... 16 × 31.5 mm and 18 × 20 ... 18 × 31.5 mm)

 012 = for bent 90° leads, blister (for \varnothing 16 ... 18 mm)



B41858

Low impedance – 105 °C

Useful life

depending on ambient temperature T_A under ripple current operating conditions¹⁾

$d = 8 \text{ mm}$

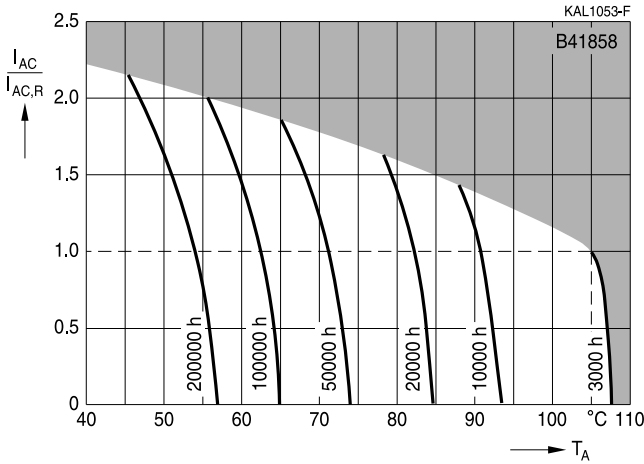

Useful life

depending on ambient temperature T_A under ripple current operating conditions¹⁾

$d \geq 10 \text{ mm}$

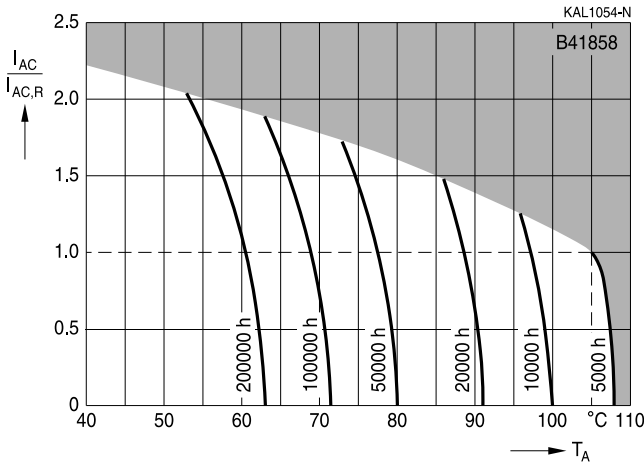

1) Refer to chapter "General technical information, 5.3 Calculation of useful life" for an explanation on how to interpret the useful life graphs.



Frequency factor of permissible ripple current I_{AC} versus frequency f

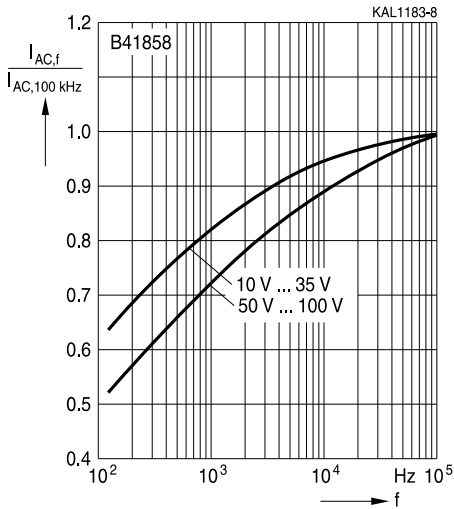



B41858

Low impedance – 105 °C

Taping, packing and lead configurations

Taping

Single-ended capacitors are available taped in Ammo pack from diameter 4 to 18 mm as follows:

Lead spacing $F = 2.0 \text{ mm}$ ($\varnothing d = 4 \dots 5 \text{ mm}$)

Lead spacing $F = 2.5 \text{ mm}$ ($\varnothing d = 4 \dots 6.3 \text{ mm}$)

Lead spacing $F = 3.5 \text{ mm}$ ($\varnothing d = 8 \text{ mm}$)

Lead spacing $F = 5.0 \text{ mm}$ ($\varnothing d = 4 \dots 12.5 \text{ mm}$)

Lead spacing $F = 7.5 \text{ mm}$ ($\varnothing d = 16 \dots 18 \text{ mm}$).

Lead spacing 2.0 mm ($\varnothing d = 4 \dots 5 \text{ mm}$)

Last 3 digits of ordering code: 016

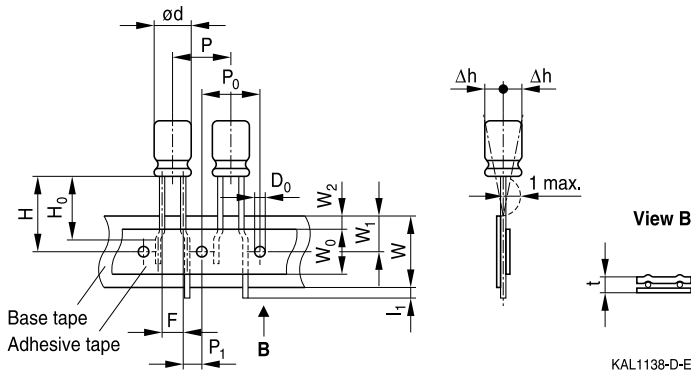

KAL1138-D-E

Dimensions in mm

$\varnothing d$	F	H	W	W_0	W_1	W_2	P	P_0	P_1	l_1	t	Δh	D_0
4 ... 5	2.0	18.5	18.0	7.0	9.0	3.0	12.7	12.7	5.10	1.0	0.7	1	4.0
	+0.8 -0.2	±0.75	±0.5	min.	±0.5	max.	±1.0	±0.3	±0.7	max.	±0.2	±1.0	±0.2

Lead spacing 2.5 mm ($\varnothing d = 4 \dots 6.3$ mm)

Last 3 digits of ordering code: 007

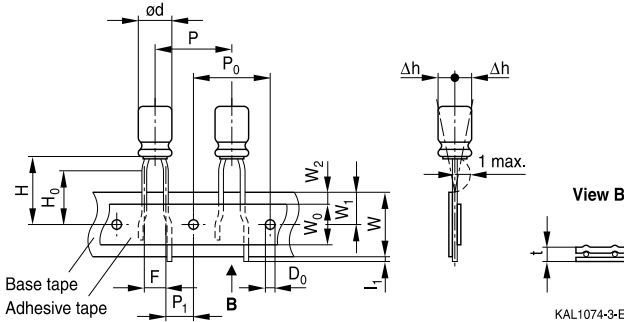
Dimensions in mm

$\varnothing d$	F	H	W	W_0	W_1	W_2	H_0	P	P_0	P_1	l_1	t	Δh	D_0
4 ... 6.3	2.5	18.5	18.0	5.5	9.0	1.5	16.0	12.7	12.7	5.1	1.0	0.7	1.0	4.0
Tolerance	+0.8 -0.2	± 0.75	± 0.5	min.	± 0.5	max.	± 0.5	± 1.0	± 0.2	± 0.5	max.	± 0.2	max.	± 0.2

Lead spacing 3.5 mm ($\varnothing d = 8$ mm)

Last 3 digits of ordering code: 006

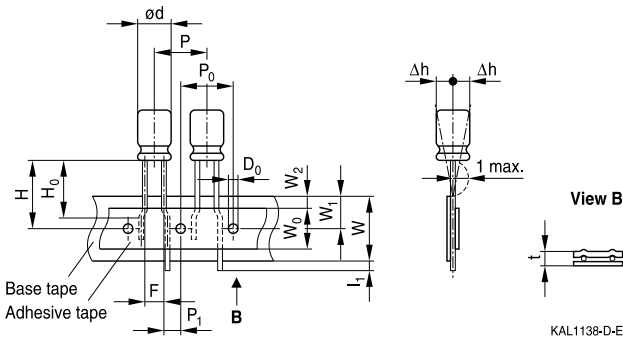
Dimensions in mm

$\varnothing d$	F	H	W	W_0	W_1	W_2	P	P_0	P_1	l_1	t	Δh	D_0
8	3.5	18.5	18.0	10	9.0	3.0	12.7	12.7	4.6	1.0	0.7	1.0	4.0
Tolerance	+0.8 -0.2	± 1.0	± 0.5	min.	± 0.5	max.	± 1.0	± 0.3	± 0.6	max.	± 0.2	max.	± 0.2

Leads can also run straight through the taping area. Taping is available up to dimensions $d \times l = 8 \times 15$ mm.



B41858

Low impedance – 105 °C

Lead spacing 5.0 mm (∅ d = 4 ... 8 mm)

Last 3 digits of ordering code: 008

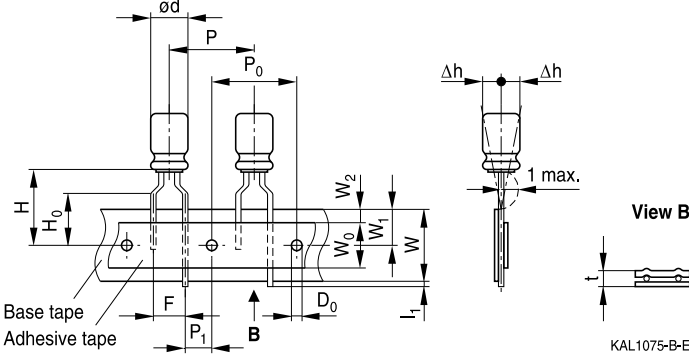

Lead spacing 5.0 mm (∅ d = 10 ... 12.5 mm)

Last 3 digits of ordering code: 008

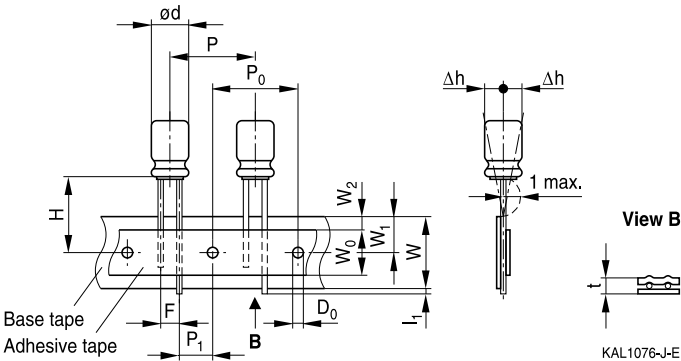

Dimensions in mm

∅ d	F	H	W	W ₀	W ₁	W ₂	H ₀	P	P ₀	P ₁	l ₁	t	Δh	D ₀
4 ... 6.3	5.0	18.5	18.0	5.5	9.0	1.5	16.0	12.7	12.7	3.85	1.0	0.6	1.0	4.0
8	5.0	20.0	18.0	10.0	9.0	1.5	16.0	12.7	12.7	3.85	1.0	0.6	1.0	4.0
		19.0		12.5			12.7	3.85						
10	5.0	19.0	18.0	12.5	9.0	1.5	–	12.7	12.7	3.85	1.0	0.6	1.0	4.0
12.5	19.0	12.5		–			15.0	15.0	5.0					
Tolerance	+0.8 –0.2	±0.75	±0.5	min.	±0.5	max.	±0.5	±1.0	±0.2	±0.5	max.	+0.3 –0.2	max.	±0.2

Taping is available up to dimensions d × l = 10 × 31.5 mm and 12.5 × 25 mm.

Taping is not available for d × l = 8 × 20 mm.

Lead spacing 7.5 mm ($\varnothing d = 16 \dots 18$ mm)

Last 3 digits of ordering code: 009

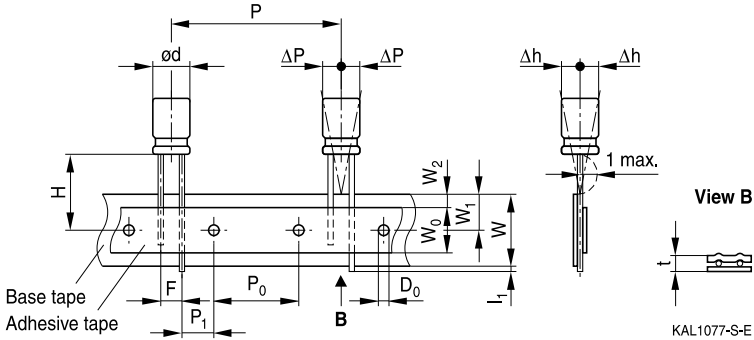
Dimensions in mm

$\varnothing d$	F	H	W	W_0	W_1	W_2	P	P_0	P_1	l_1	t	ΔP	Δh	D_0
16	7.5	18.5	18.0	12.5	9.0	1.5	30.0	15.0	3.75	1.0	0.7	0	0	4.0
18														
Tolerance	± 0.8	-0.5 $+0.75$	± 0.5	min.	± 0.5	max.	± 1.0	± 0.2	± 0.5	max.	± 0.2	± 1.0	± 1.0	± 0.2

 Taping is available up to dimensions $d \times l = 16 \times 31.5$ mm and 18×31.5 mm.



B41858

Low impedance – 105 °C

Cut or kinked leads

Single-ended capacitors are available with cut or kinked leads. Other lead configurations also available upon request.

Cut leads (Chapter A)

Available for series B41002, B41022, B41044, B41827, B41828, B43044, B43082, B43086, B43088, B43827, B43828.

Last 3 digits of ordering code: 002

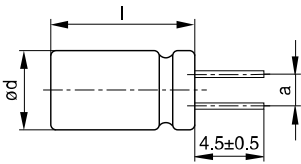

KAL1086-R

Case size d x l (mm)	Dimensions (mm) a ±0.5
4 x 7	1.5
5 x 7	2.0
5 x 11	2.0
6.3 x 7	2.5
6.3 x 11	2.5
8 x 7	3.5
8 x 11.5	3.5
8 x 15	3.5
8 x 20	3.5
10 x 12.5	5.0
10 x 16	5.0
10 x 20	5.0
10 x 25	5.0
10 x 31.5	5.0

Case size d x l (mm)	Dimensions (mm) a ±0.5
12.5 x 16	5.0
12.5 x 20	5.0
12.5 x 25	5.0
12.5 x 31.5	5.0
12.5 x 35.5	5.0
12.5 x 40	5.0
16 x 20	7.5
16 x 25	7.5
16 x 31.5	7.5
16 x 35.5	7.5
16 x 40	7.5
18 x 20	7.5
18 x 25	7.5
18 x 31.5	7.5
18 x 35.5	7.5
18 x 40	7.5



Cut leads (Chapter B)

Available for series B41858, B41859, B41863, B41866, B41868, B41888, B41890, B41896, B42824, B42851, B43866, B43867, B43890, B43896.

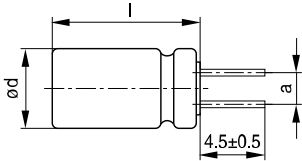
Last 3 digits of ordering code: 002

With stand-off rubber seal

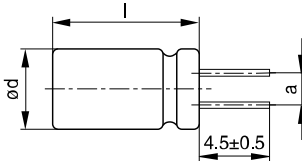
KAL1085-I

With flat rubber seal

KAL1086-R

Case size d × l (mm)	Dimensions (mm) a ±0.5
10 × 12.5	5.0
10 × 16	5.0
10 × 20	5.0
12.5 × 20	5.0
12.5 × 25	5.0
16 × 20	7.5
16 × 25	7.5
16 × 31.5	7.5
16 × 35.5	7.5
18 × 20	7.5
18 × 25	7.5
18 × 31.5	7.5
18 × 35	7.5
18 × 40	7.5



B41858

Low impedance – 105 °C

Kinked leads (Chapter A)

Available for series B41002, B41022, B41044, B41827, B41828, B43044, B43082, B43086, B43088, B43827, B43828.

Last 3 digits of ordering code: 001

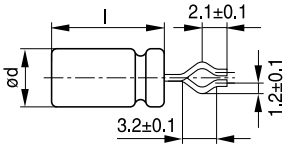

KAL1137-5

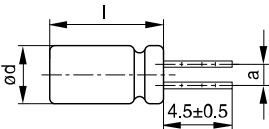

KAL1084-A

Case size d x l (mm)	Dimensions (mm) a ±0.5
4 x 7	1.5
5 x 7	2.0
5 x 11	2.0
6.3 x 7	2.5
6.3 x 11	2.5
8 x 7	3.5
8 x 11.5	3.5
8 x 15	3.5
8 x 20	3.5
10 x 12.5	5.0
10 x 16	5.0
10 x 20	5.0
10 x 25	5.0
10 x 31.5	5.0

Case size d x l (mm)	Dimensions (mm) a ±0.5
12.5 x 16	5.0
12.5 x 20	5.0
12.5 x 25	5.0
12.5 x 31.5	5.0
12.5 x 35.5	5.0
12.5 x 40	5.0
16 x 20	7.5
16 x 25	7.5
16 x 31.5	7.5
16 x 35.5	7.5
16 x 40	7.5
18 x 20	7.5
18 x 25	7.5
18 x 31.5	7.5
18 x 35.5	7.5
18 x 40	7.5



Kinked leads (Chapter B)

Available for series B41858, B41859, B41863, B41866, B41868, B41888, B41890, B41896, B42824, B42851, B43866, B43867, B43890, B43896.

Last 3 digits of ordering code: 001

With stand-off rubber seal

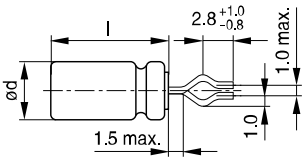

KAL1081-K

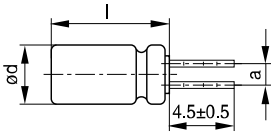

KAL1083-2

With flat rubber seal

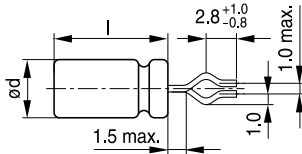

KAL1082-T

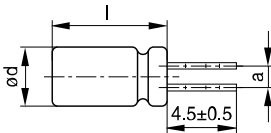

KAL1084-A

Case size d × l (mm)	Dimensions (mm) a ±0.5
10 × 20	5.0
12.5 × 20	5.0
12.5 × 25	5.0
16 × 20	7.5
16 × 25	7.5
16 × 31.5	7.5
16 × 35.5	7.5
18 × 20	7.5
18 × 25	7.5
18 × 31.5	7.5
18 × 35	7.5
18 × 40	7.5



B41858

Low impedance – 105 °C

PAPR leads (Protection Against Polarity Reversal)

These lead configurations ensure correct placement of the capacitor on the PCB with regard to polarity. PAPR leads are available for diameters from 10 mm up to 18 mm.

There are three configurations available: Crimped leads, J leads, bent 90° leads

Available for series B41858, B41859, B41863, B41866, B41868, B41888, B41890, B41896, B42824, B42851, B43866, B43867, B43890, B43896.

Crimped leads

Last 3 digits of ordering code: 003

With stand-off rubber seal

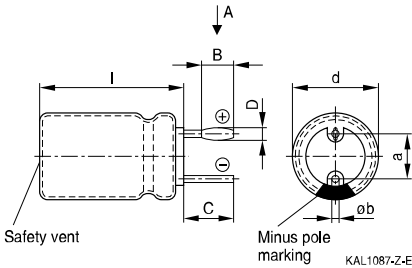

With flat rubber seal

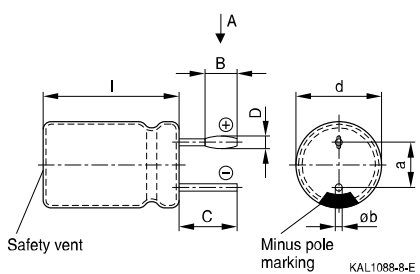

Suggestion for PCB hole diameter

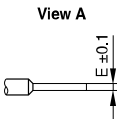

Suggestion for PCB hole diameter, wire ø0,8 mm

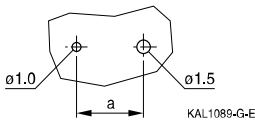

Suggestion for PCB hole diameter, wire ø1.0 mm

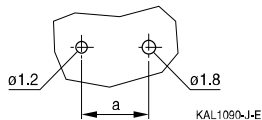

Case size d × l (mm)	Dimensions (mm)					
	B ±0.2	C ±0.5	D ±0.1	E ±0.1	a ±0.5	Øb
16 × 20	1.5	3.0	1.3	0.3	7.5	0.8 ±0.05
16 × 25	1.5	3.0	1.3	0.3	7.5	0.8 ±0.05
16 × 31.5	1.5	3.0	1.3	0.3	7.5	0.8 ±0.05
16 × 35.5	1.5	3.0	1.3	0.3	7.5	0.8 ±0.05
18 × 20	1.5	3.0	1.3	0.3	7.5	0.8 ±0.1
18 × 25	1.5	3.0	1.3	0.3	7.5	0.8 ±0.1
18 × 31.5	1.5	3.0	1.3	0.3	7.5	0.8 ±0.1
18 × 35	1.5	3.0	1.3	0.3	7.5	0.8 ±0.1
18 × 40	1.5	3.0	1.3	0.3	7.5	0.8 ±0.1

J leads

Last 3 digits of ordering code: 004

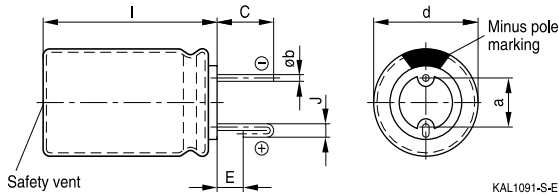
Suggestion for PCB hole diameter

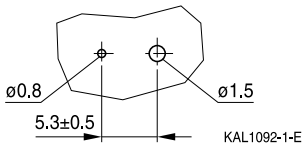
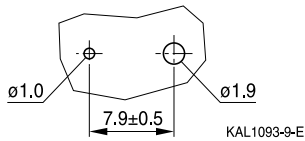
 Suggestion for PCB hole diameter,
wire $\varnothing 0.6$ mm

 Suggestion for PCB hole diameter,
wire $\varnothing 0.8$ mm

Case size $d \times l$ (mm)	Dimensions (mm)				
	$C \pm 0.5$	$E \pm 0.5$	$J \pm 0.2$	$a \pm 0.5$	$\varnothing b$
10 × 12.5	3.2	0.7	1.2	5.0	0.6 ± 0.05
10 × 16	3.2	0.7	1.2	5.0	0.6 ± 0.05
10 × 20	3.2	0.7	1.2	5.0	0.6 ± 0.05
12.5 × 20	3.2	0.7	1.2	5.0	0.6 ± 0.05
12.5 × 25	3.2	0.7	1.2	5.0	0.6 ± 0.05
16 × 20	3.5	0.7	1.6	7.5	0.8 ± 0.05
16 × 25	3.5	0.7	1.6	7.5	0.8 ± 0.05
16 × 31.5	3.5	0.7	1.6	7.5	0.8 ± 0.05
16 × 35.5	3.5	0.7	1.6	7.5	0.8 ± 0.05
18 × 20	3.5	0.7	1.6	7.5	0.8 ± 0.1
18 × 25	3.5	0.7	1.6	7.5	0.8 ± 0.1
18 × 31.5	3.5	0.7	1.6	7.5	0.8 ± 0.1
18 × 35	3.5	0.7	1.6	7.5	0.8 ± 0.1



B41858

Low impedance – 105 °C

Bent 90° leads for horizontal mounting pinning

Last 3 digits of ordering code: 012

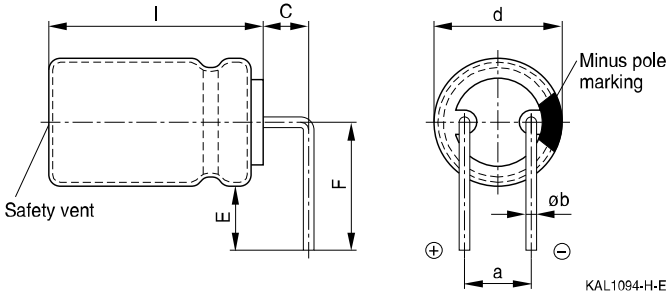

Case size d × l (mm)	Dimensions (mm)				
	C ±0.5	E ±0.5	F ±0.5	a ±0.5	Øb
16 × 20	4.0	4.0	12.0	7.5	0.8 ±0.05
16 × 25	4.0	4.0	12.0	7.5	0.8 ±0.05
16 × 31.5	4.0	4.0	12.0	7.5	0.8 ±0.05
16 × 35.5	4.0	4.0	12.0	7.5	0.8 ±0.05
18 × 20	4.0	4.0	13.0	7.5	0.8 ±0.1
18 × 25	4.0	4.0	13.0	7.5	0.8 ±0.1
18 × 31.5	4.0	4.0	13.0	7.5	0.8 ±0.1
18 × 35	4.0	4.0	13.0	7.5	0.8 ±0.1
18 × 40	4.0	4.0	13.0	7.5	0.8 ±0.1

Bent leads for diameter 12.5 mm available upon request.



Packing units and box dimensions

Ammo pack

Valid for series B41002, B41022, B41044, B41827, B41828, B43044, B43082, B43086, B43088, B43827, B43828.

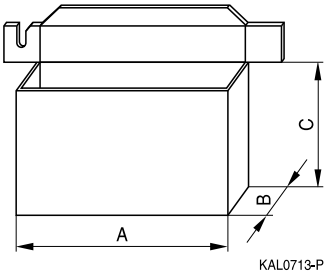

Case size d × l mm	Dimensions (mm)			Packing units pcs.
	A _{max}	B _{max}	C _{max}	
4 × 7	330	50	196	2000
5 × 7	330	50	226	2000
5 × 11	330	50	226	2000
6.3 × 7	330	50	286	2000
6.3 × 11	330	50	286	2000
8 × 7	330	50	246	1000
8 × 11.5	330	50	246	1000
8 × 15	330	50	246	500
10 × 12.5	330	50	196	500
10 × 16	330	54	196	500
10 × 20	330	58	196	500
12.5 × 20	341	60	272	500
12.5 × 25	341	65	272	500
16 × 25	320	65	270	300
16 × 31.5	315	65	275	300
18 × 20	315	65	275	250
18 × 25	315	65	275	250
18 × 31.5	315	65	275	250



B41858

Low impedance – 105 °C

Ammo pack

Valid for series B41858, B41859, B41863, B41866, B41868, B41888, B41890, B41896, B42824, B42851, B43866, B43867, B43890, B43896.

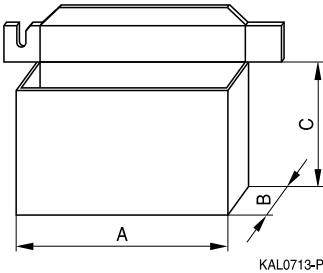

Case size d × l mm	Dimensions (mm)			Packing units pcs.
	A _{max}	B _{max}	C _{max}	
8 × 11.5	345	55	240	1000
10 × 12.5	345	55	280	750
10 × 16	345	60	200	500
10 × 20	345	60	200	500
12.5 × 20	345	65	280	500
12.5 × 25	345	65	280	500
16 × 20	315	65	275	300
16 × 25	315	65	275	300
16 × 31.5	315	65	275	300
18 × 20	315	65	275	250
18 × 25	315	65	275	250
18 × 31.5	315	65	275	250

Overview of packing units and code numbers for case sizes 4 x 7 ... 16 x 40

Valid for series B41002, B41022, B41044, B41827, B41828, B43044, B43082, B43086, B43088, B43827, B43828.

Case size d x l mm	Standard, bulk pcs.	Taped, Ammo pack pcs.	Kinked leads, bulk pcs.	Cut leads, bulk pcs.		
4 x 7	10000	2000	15000	15000		
5 x 7	7500	2000	10000	10000		
5 x 11	5000	2000	10000	10000		
6.3 x 7	5000	2000	10000	10000		
6.3 x 11	5000	2000	5000	5000		
8 x 7	5000	1000	5000	5000		
8 x 11.5	2500	1000	4000	4000		
8 x 15	2000	1000	2500	2500		
8 x 20	1500	–	2000	2000		
10 x 12.5	2000	500	2500	2500		
10 x 16	1500	500	2000	2000		
10 x 20	1000	500	1500	1500		
10 x 25	1000	500	1250	1250		
12.5 x 16	750	500	1000	1000		
12.5 x 20	750	500	500	500		
12.5 x 25	750	500	500	500		
12.5 x 31.5	500	–	750	750		
12.5 x 35.5	500	–	750	750		
12.5 x 40	500	–	750	750		
16 x 20	375	300	500	500		
16 x 25	375	300	500	500		
16 x 31.5	250	300	375	375		
16 x 35.5	250	–	375	375		
16 x 40	250	–	375	375		
The last three digits of the complete ordering code state the lead configuration	000	Code	F (mm)	d (mm)	001	002
		006	3.5	8		
		007	2.5	4 ... 6.3		
		008	5.0	4 ... 12.5		
		009	7.5	16 ... 18		
		016	2.0	4 ... 5		

B41858
Low impedance – 105 °C
Overview of packing units and code numbers for case sizes 18 x 20 ... 18 x 40

Valid for series B41002, B41022, B41044, B41827, B41828, B43044, B43082, B43086, B43088, B43827, B43828.

Case size d x l mm	Standard, bulk pcs.	Taped, Ammo pack pcs.			Kinked leads, bulk pcs.	Cut leads, bulk pcs.
18 x 20	250	250			100	100
18 x 25	250	250			100	100
18 x 31.5	250	250			100	100
18 x 35.5	250	–			100	100
18 x 40	250	–			100	100
The last three digits of the complete ordering code state the lead configuration	000	Code	F (mm)	d (mm)	001	002
		009	7.5	16 ... 18		

Overview of packing units and code numbers for case sizes 8 × 11.5 ... 16 × 35.5

Valid for series B41858, B41859, B41863, B41866, B41868, B41888, B41890, B41896, B42824, B42851, B43866, B43867, B43890, B43896.

					PAPR				
Case size d × l	Stan- dard, bulk	Taped, Ammo pack			Kinked leads, bulk	Cut leads, bulk	Crimped leads, blister	J leads, blister	Bent 90° leads, blister
mm	pcs.	pcs.		pcs.	pcs.	pcs.	pcs.	pcs.	
8 × 11.5	1000	1000		–	–	–	–		
10 × 12.5	1000	750		–	1000	–	675		
10 × 16	1000	500		–	1000	–	675		
10 × 20	500	500		500	500	–	500		
12.5 × 20	350	500		350	350	–	300	1)	
12.5 × 25	250	500		500	500	–	225	1)	
12.5 × 30	200	–		–	–	–	–		
12.5 × 35	175	–		–	–	–	–		
12.5 × 40	175	–		–	–	–	–		
16 × 20	250	300		200	200	200	200	120	
16 × 25	250	300		200	200	200	200	120	
16 × 31.5	200	300		250	250	344	344	120	
16 × 35.5	100	–		100	100	150	150	150	
The last three digits of the complete ordering code state the lead configuration	000	Code	F (mm)	d (mm)	001	002	003	004	012
		006	3.5	8					
		008	5	5...12.5					
		009	7.5	16...18					

1) Available upon request

B41858
Low impedance – 105 °C
Overview of packing units and code numbers for case sizes 18 × 20 ... 18 × 40

Valid for series B41858, B41859, B41863, B41866, B41868, B41888, B41890, B41896, B42824, B42851, B43866, B43867, B43890, B43896.

					PAPR				
Case size d × l mm	Standard, bulk pcs.	Taped, Ammo pack pcs.			Kinked leads, bulk pcs.	Cut leads, bulk pcs.	Crimped leads, blister pcs.	J leads, blister pcs.	Bent 90° leads, blister pcs.
18 × 20	175	250			175	175	200	200	120
18 × 25	150	250			150	150	200	200	120
18 × 31.5	100	250			100	100	150	150	120
18 × 35	100	–			100	100	150	150	150
18 × 40	125	–			100	100	120	–	72
The last three digits of the complete ordering code state the lead configuration	000	Code	F (mm)	d (mm)	001	002	003	004	012
		009	7.5	16...18					



Cautions and warnings

Personal safety

The electrolytes used by EPCOS have not only been optimized with a view to the intended application, but also with regard to health and environmental compatibility. They do not contain any solvents that are detrimental to health, e.g. dimethyl formamide (DMF) or dimethyl acetamide (DMAC).

Furthermore, part of the high-voltage electrolytes used by EPCOS are self-extinguishing. They contain flame-retarding substances which will quickly extinguish any flame that may have been ignited.

As far as possible, EPCOS does not use any dangerous chemicals or compounds to produce operating electrolytes. However, in exceptional cases, such materials must be used in order to achieve specific physical and electrical properties because no safe substitute materials are currently known. However, the amount of dangerous materials used in our products has been limited to an absolute minimum. Nevertheless, the following rules should be observed when handling aluminum electrolytic capacitors:

- Any escaping electrolyte should not come into contact with eyes or skin.
- If electrolyte does come into contact with the skin, wash the affected parts immediately with running water. If the eyes are affected, rinse them for 10 minutes with plenty of water. If symptoms persist, seek medical treatment.
- Avoid breathing in electrolyte vapor or mists. Workplaces and other affected areas should be well ventilated. Clothing that has been contaminated by electrolyte must be changed and rinsed in water.



Product safety

The table below summarizes the safety instructions that must be observed without fail. A detailed description can be found in the relevant sections of chapter "General technical information".

Topic	Safety information	Reference chapter "General technical information"
Polarity	Make sure that polar capacitors are connected with the right polarity.	1 "Basic construction of aluminum electrolytic capacitors"
Reverse voltage	Voltages polarity classes should be prevented by connecting a diode.	3.1.6 "Reverse voltage"
Upper category temperature	Do not exceed the upper category temperature.	7.2 "Maximum permissible operating temperature"
Maintenance	Make periodic inspections of the capacitors. Before the inspection, make sure that the power supply is turned off and carefully discharge the electricity of the capacitors. Do not apply any mechanical stress to the capacitor terminals.	10 "Maintenance"
Mounting position of screw-terminal capacitors	Do not mount the capacitor with the terminals (safety vent) upside down.	11.1. "Mounting positions of capacitors with screw terminals"
Mounting of single-ended capacitors	The internal structure of single-ended capacitors might be damaged if excessive force is applied to the lead wires. Avoid any compressive, tensile or flexural stress. Do not move the capacitor after soldering to PC board. Do not pick up the PC board by the soldered capacitor. Do not insert the capacitor on the PC board with a hole space different to the lead space specified.	11.4 "Mounting considerations for single-ended capacitors"
Robustness of terminals	The following maximum tightening torques must not be exceeded when connecting screw terminals: M5: 2 Nm M6: 2.5 Nm	11.3 "Mounting torques"
Soldering	Do not exceed the specified time or temperature limits during soldering.	11.5 "Soldering"



Topic	Safety information	Reference chapter "General technical information"
Soldering, cleaning agents	Do not allow halogenated hydrocarbons to come into contact with aluminum electrolytic capacitors.	11.6 "Cleaning agents"
Passive flammability	Avoid external energy, such as fire or electricity.	8.1 "Passive flammability"
Active flammability	Avoid overload of the capacitors.	8.2 "Active flammability"
		Reference chapter "Capacitors with screw terminals"
Breakdown strength of insulating sleeves	Do not damage the insulating sleeve, especially when ring clips are used for mounting.	"Screw terminals – accessories"

B41858
Low impedance – 105 °C
Symbols and terms

Symbol	English	German
C	Capacitance	Kapazität
C_R	Rated capacitance	Nennkapazität
C_S	Series capacitance	Serienkapazität
$C_{S,T}$	Series capacitance at temperature T	Serienkapazität bei Temperatur T
C_f	Capacitance at frequency f	Kapazität bei Frequenz f
d	Case diameter, nominal dimension	Gehäusedurchmesser, Nennmaß
d_{max}	Maximum case diameter	Maximaler Gehäusedurchmesser
ESL	Self-inductance	Eigeninduktivität
ESR	Equivalent series resistance	Ersatzserienwiderstand
ESR_f	Equivalent series resistance at frequency f	Ersatzserienwiderstand bei Frequenz f
ESR_T	Equivalent series resistance at temperature T	Ersatzserienwiderstand bei Temperatur T
f	Frequency	Frequenz
I	Current	Strom
I_{AC}	Alternating current (ripple current)	Wechselstrom
$I_{AC,rms}$	Root-mean-square value of alternating current	Wechselstrom, Effektivwert
$I_{AC,f}$	Ripple current at frequency f	Wechselstrom bei Frequenz f
$I_{AC,max}$	Maximum permissible ripple current	Maximal zulässiger Wechselstrom
$I_{AC,R}$	Rated ripple current	Nennwechselstrom
$I_{AC,R} (B)$	Rated ripple current for base cooling	Nennwechselstromstrom für Bodenkühlung
I_{leak}	Leakage current	Reststrom
$I_{leak,op}$	Operating leakage current	Betriebsreststrom
l	Case length, nominal dimension	Gehäuselänge, Nennmaß
l_{max}	Maximum case length (without terminals and mounting stud)	Maximale Gehäuselänge (ohne Anschlüsse und Gewindebolzen)
R	Resistance	Widerstand
R_{ins}	Insulation resistance	Isolationswiderstand
R_{symm}	Balancing resistance	Symmetrierwiderstand
T	Temperature	Temperatur
ΔT	Temperature difference	Temperaturdifferenz
T_A	Ambient temperature	Umgebungstemperatur
T_C	Case temperature	Gehäusetemperatur
T_B	Capacitor base temperature	Temperatur des Becherbodens
t	Time	Zeit
Δt	Period	Zeitraum
t_b	Service life (operating hours)	Brauchbarkeitsdauer (Betriebszeit)



Symbol	English	German
V	Voltage	Spannung
V _F	Forming voltage	Formierspannung
V _{op}	Operating voltage	Betriebsspannung
V _R	Rated voltage, DC voltage	Nennspannung, Gleichspannung
V _S	Surge voltage	Spitzenspannung
X _C	Capacitive reactance	Kapazitiver Blindwiderstand
X _L	Inductive reactance	Induktiver Blindwiderstand
Z	Impedance	Scheinwiderstand
Z _T	Impedance at temperature T	Scheinwiderstand bei Temperatur T
tan δ	Dissipation factor	Verlustfaktor
λ	Failure rate	Ausfallrate
ε ₀	Absolute permittivity	Elektrische Feldkonstante
ε _r	Relative permittivity	Dielektrizitätszahl
ω	Angular velocity; 2 · π · f	Kreisfrequenz; 2 · π · f

Note

All dimensions are given in mm.

Important notes

The following applies to all products named in this publication:

1. Some parts of this publication contain **statements about the suitability of our products for certain areas of application**. These statements are based on our knowledge of typical requirements that are often placed on our products in the areas of application concerned. We nevertheless expressly point out **that such statements cannot be regarded as binding statements about the suitability of our products for a particular customer application**. As a rule, EPCOS is either unfamiliar with individual customer applications or less familiar with them than the customers themselves. For these reasons, it is always ultimately incumbent on the customer to check and decide whether an EPCOS product with the properties described in the product specification is suitable for use in a particular customer application.
2. We also point out that **in individual cases, a malfunction of electronic components or failure before the end of their usual service life cannot be completely ruled out in the current state of the art, even if they are operated as specified**. In customer applications requiring a very high level of operational safety and especially in customer applications in which the malfunction or failure of an electronic component could endanger human life or health (e.g. in accident prevention or lifesaving systems), it must therefore be ensured by means of suitable design of the customer application or other action taken by the customer (e.g. installation of protective circuitry or redundancy) that no injury or damage is sustained by third parties in the event of malfunction or failure of an electronic component.
3. **The warnings, cautions and product-specific notes must be observed.**
4. In order to satisfy certain technical requirements, **some of the products described in this publication may contain substances subject to restrictions in certain jurisdictions (e.g. because they are classed as hazardous)**. Useful information on this will be found in our Material Data Sheets on the Internet (www.epcos.com/material). Should you have any more detailed questions, please contact our sales offices.
5. We constantly strive to improve our products. Consequently, **the products described in this publication may change from time to time**. The same is true of the corresponding product specifications. Please check therefore to what extent product descriptions and specifications contained in this publication are still applicable before or when you place an order. We also **reserve the right to discontinue production and delivery of products**. Consequently, we cannot guarantee that all products named in this publication will always be available. The aforementioned does not apply in the case of individual agreements deviating from the foregoing for customer-specific products.
6. Unless otherwise agreed in individual contracts, **all orders are subject to the current version of the "General Terms of Delivery for Products and Services in the Electrical Industry" published by the German Electrical and Electronics Industry Association (ZVEI)**.
7. The trade names EPCOS, BAOKE, Alu-X, CeraDiode, CSMP, CSSP, CTVS, DeltaCap, DigiSiMic, DSSP, FormFit, MiniBlue, MiniCell, MKK, MKD, MLSC, MotorCap, PCC, PhaseCap, PhaseCube, PhaseMod, PhiCap, SIFERRIT, SIFI, SIKOREL, SilverCap, SIMDAD, SiMic, SIMID, SineFormer, SIOV, SIP5D, SIP5K, ThermoFuse, WindCap are **trade-marks registered or pending** in Europe and in other countries. Further information will be found on the Internet at www.epcos.com/trademarks.